



# Container transport trailer MG18-ZL 5.4

The high-quality trailer for roll-off containers

| [meiller.com](https://meiller.com)

# Container transport trailer MG18-ZL 5.4

The high-quality trailer for roll-off containers

The MEILLER container transport trailer for roll-off containers is designed for daily, rugged use. Drive economically over a long lifetime with high-quality MEILLER components and excellent standard equipment.

Use the MEILLER container transport trailer very flexibly: they can transport a variety of roll-off containers from 5 to 7 m in length.

## Your benefits:

- **Durable due to rigid chassis frame**
- **Low wear due to closed, low-deformation outer guide roller**
- **Flexible and safe transport due to:**
  - 4x pneumatic container locking system
  - Pluggable container stops
  - Additional container stops for medium container lengths
- **Environmentally-friendly and corrosion-free KTL dip primer**



Screw-type underrun protection according to ECE-58R-03 with rubber stop buffer  
Folding A-plate

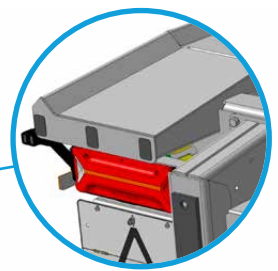

Easy transfer of the container due to funnel-shaped roller insertion

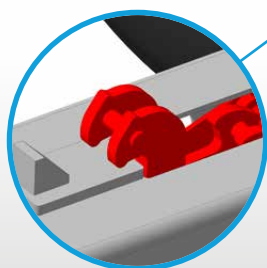

4x pneumatic hook locking (forced locking at speeds > 5 km/h)

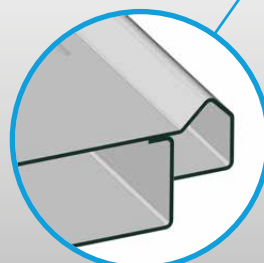

Lateral forced fixation of the container (bolted low-deformation rail guide in stepped design)

LED lamps in ECO-LED II technology, with flashing side marker lights

## Technical data

<b>For roll-off containers with lengths of 5-7 m acc. to</b>	DIN 30 722-1/2
	DIN 14 505
<b>Payload</b>	Up to 14 650 kg
<b>Height</b>	Low translation height: 990 mm
<b>Length</b>	Overall length: 9 700 mm (drawbar 2 600 mm)
	Length of load area: 7 115 mm
	Wheelbase: 5 400 mm
<b>Width</b>	Max. overall width: 2 550 mm
	Max. width of the load area: 2 175 mm
<b>Weight</b>	Basic version: 3 350 kg
<b>Tyres</b>	265/70 R 19.5" with disc brakes

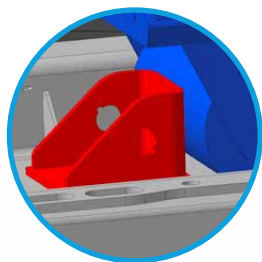

Additional stop position for container rollers for medium-length roll-off containers



Universal pluggable front container stops

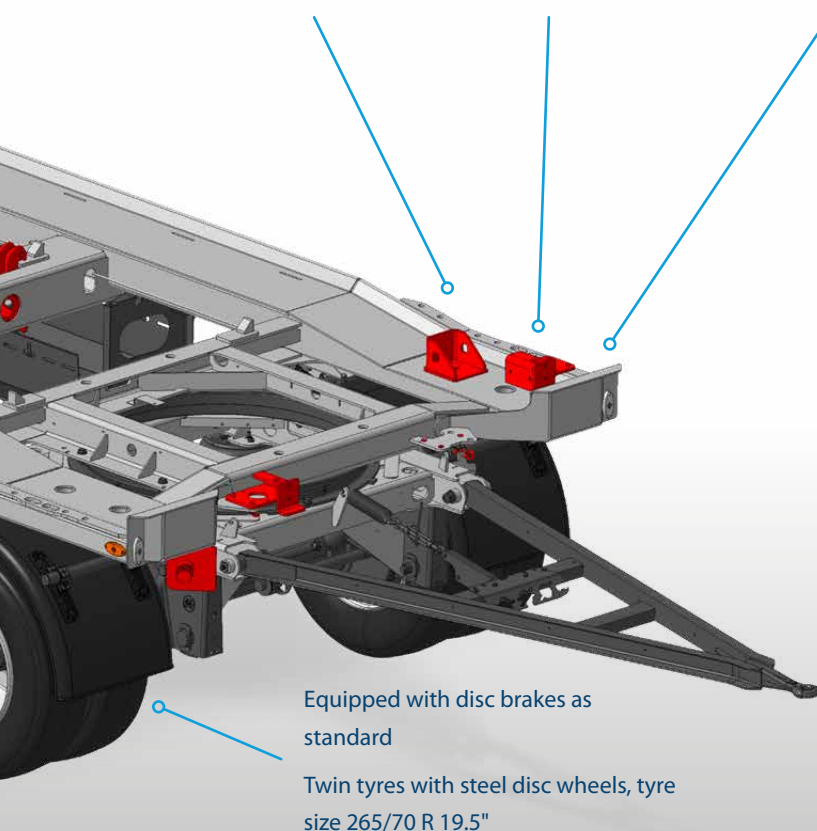

Equipped with disc brakes as standard

Twin tyres with steel disc wheels, tyre size 265/70 R 19.5"

## Attachment parts and accessories

- Screw-type underrun protection according to ECE-58R-03
- Lightweight, screw-type and folding side protective devices
- Lashing lugs at the side for load securing
- Integrated lockable tool box
- Corrosion-protected net box
- Convenient monitoring via SmartBoard®
- LED working lights

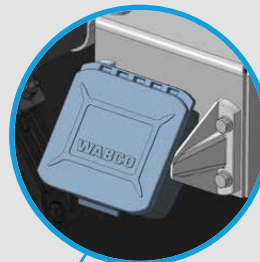

Maintain a perfect overview with the standard, side-mounted SmartBoard®

- Weight monitoring through additional pressure sensor
- Trip odometer
- Total trip odometer
- Manual lifting & lowering
- Error memory, etc.

### Optional:

- Rear area camera
- Spare wheel holder and spare wheel
- Adapter 15-pin to 2x7-pin
- Drawbar lengths 2 500 mm and 2 700 mm
- Drum brakes

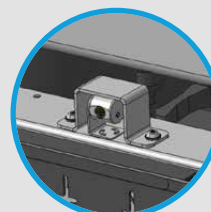

Rear area camera for monitoring the working area at the rear

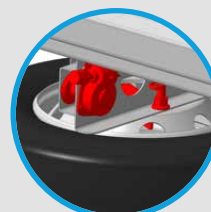

Spare wheel holder and spare wheel, easily accessible and easy to operate

# MEILLER in your area

Full service from a single source

## Present worldwide

- MEILLER locations/sales offices
- Service workshops

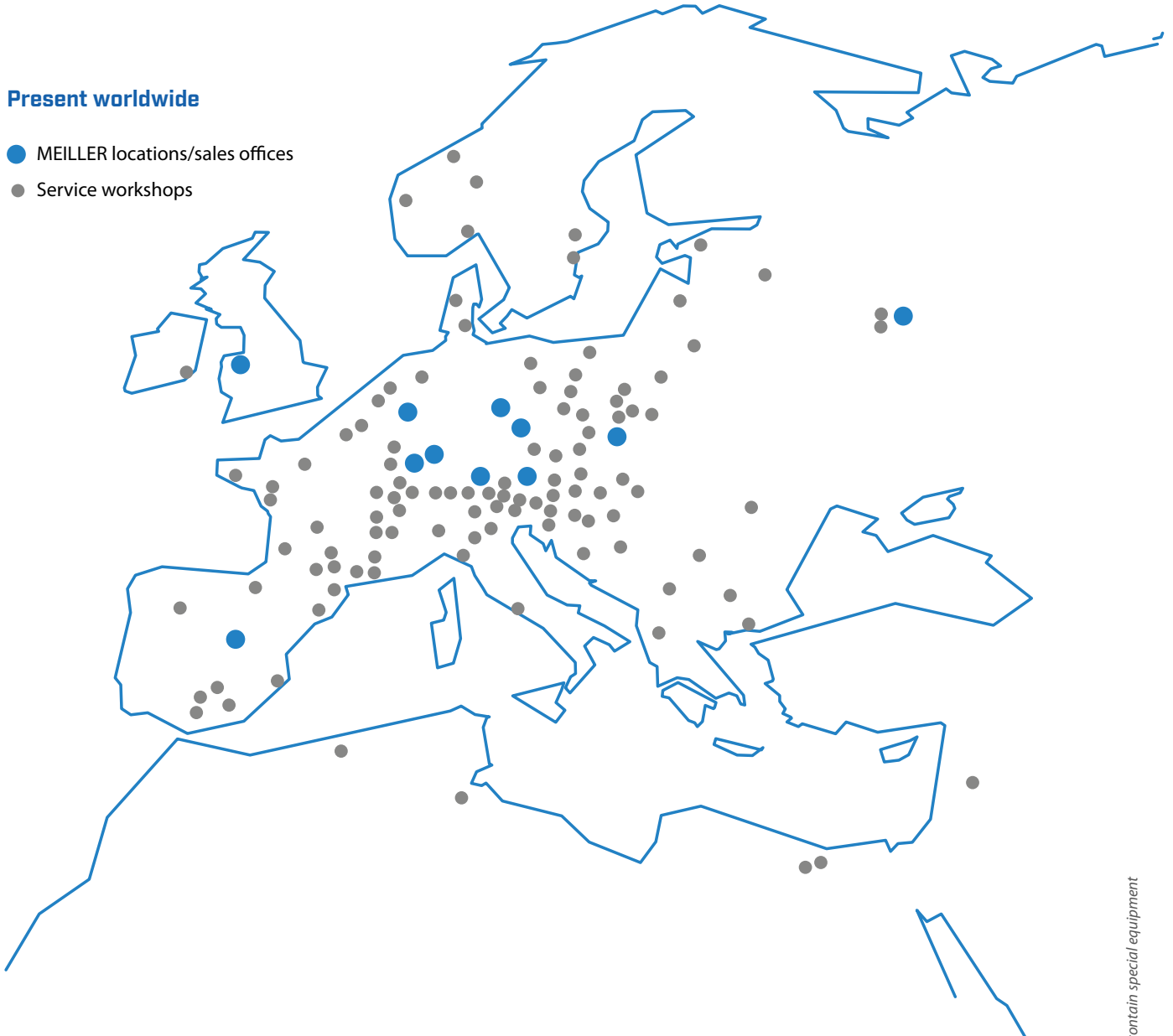

There's a MEILLER location near you.  
Find the service workshops closest to  
you by searching online at  
[meiller.com/service](http://meiller.com/service)

1787\_En-791-0821  
Figure similar, may contain special equipment

**F.X. MEILLER**

Fahrzeug- und Maschinenfabrik - GmbH & Co KG · Ambossstraße 4 · 80997 Munich, Germany  
Telefon: +49 89 1487 - 0 · Telefax: +49 89 1487-1355 / 1595 · [info@meiller.com](mailto:info@meiller.com) · [www.meiller.com](http://www.meiller.com)